



THE MINI 3-DOOR, THE MINI 5-DOOR.



For more than 55 years, the MINI has made the revolutionary routine. It's broken all the old rules and set new standards. It's taken inner-city driving and personalization to the next level. And it's always packed with inspirational technology. Its unmistakable design and iconic go-kart feeling are practically the only traditions it won't break with. But that's because the best ones always endure. Old or new, past or present, the MINI has always been more than a car – it's a statement too.

MAKING A HABIT OF BREAKING CONVENTION.

Details of fuel consumption and CO₂ emissions for all models, as required under EU law, can be found in the Technical Data section beginning on page 42.

For more information on the options available for each model, contact your MINI dealer or visit [mini.com/configurator](https://www.mini.com/configurator)



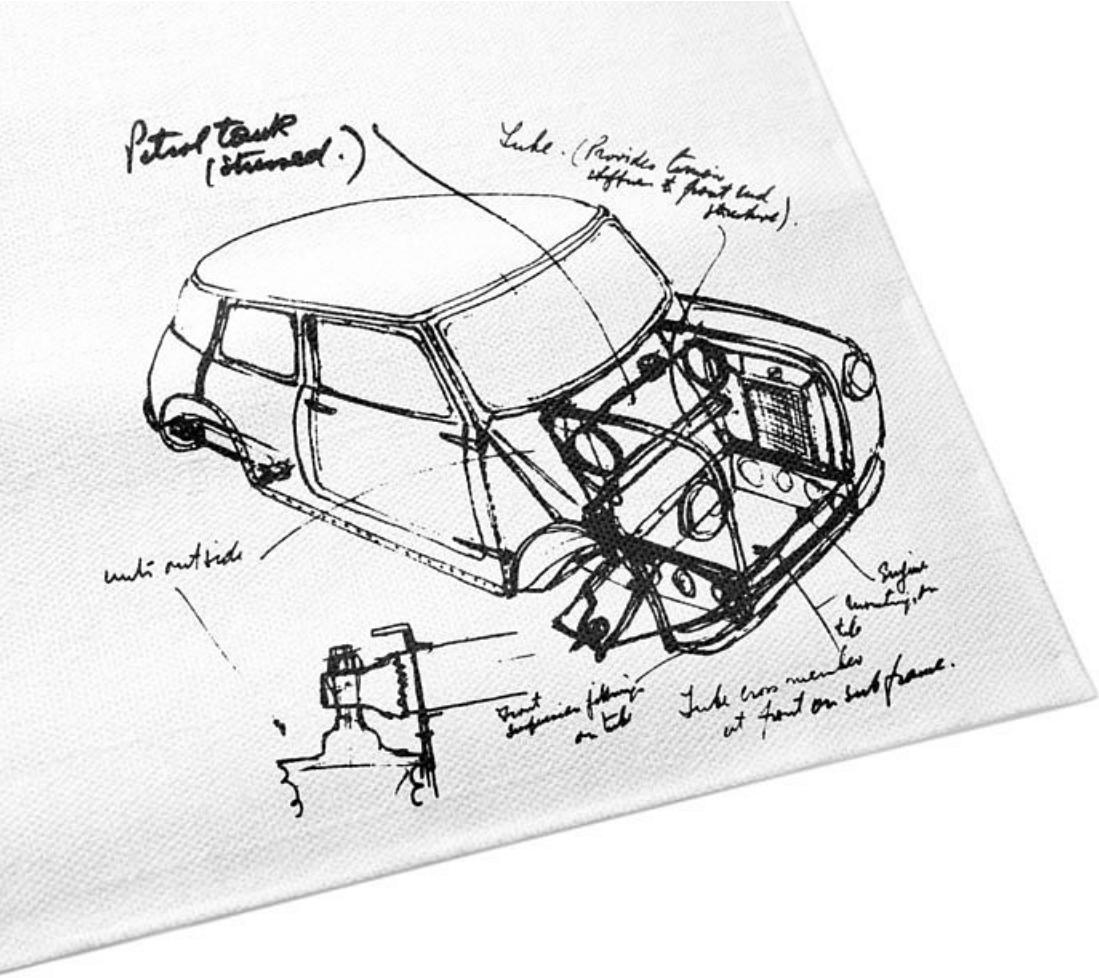

MAKING THE MINI: BREAKING THE MOULD.

When Sir Alec Issigonis sketched his initial idea for the Mini on a tablecloth in 1956, his innovative compact design was the perfect response to some of the biggest automotive questions of his era. Almost everything about it was unconventional: he increased the track width as far as he could, mounted the engine lengthwise, and positioned the instrument cluster centrally for both left and right-hand drive. This ensured maximum space inside the car. The concept was unprecedented – and his revolutionary Mini soon became an icon.

Motorsport legend John Cooper saw star racing potential in the original Mini – so he created a model for the track. Braking, inducing oversteer and then drifting around corners became effortless for rally drivers, thanks to its light weight and short overhangs. Racing around tight bends at high speed, now synonymous with the classic MINI go-kart feeling, laid the foundation for a succession of spectacular wins at the Monte Carlo rally. Here, the Mini proved that agile handling beats sheer power, every time. To honour Cooper's vision, the thoroughbreds of the MINI range bear the name John Cooper Works.

The compact design of Alec Issigonis and racing pedigree of John Cooper have defined the Mini from the very beginning and remain hallmarks of every iteration to this day. Their legacy of innovation lives on in the latest MINI – and the cutting-edge technology within.











With a streamlined front end and muscular sides, the classic MINI profile is unmistakable. Once you've caught the eye of those around you, the side scuttles, roof and exterior mirror caps in Aspen White and elongated roof line with spoiler lip are sure to hold their gaze as you dash into the distance.

AN EXCEPTIONAL MINI WITH EQUIPMENT TO MATCH.

Which model do you want? How many doors? What should it look like inside? And what cutting-edge bag of tricks should it have up its sleeve? With any MINI, the possibilities are endless. Take the 5-door MINI Cooper in Moonwalk Grey shown above, for example. It sports bonnet stripes, roof and exterior mirror caps in Jet Black, LED headlights and fog lights, White direction indicators and 2-tone 17" Roulette Spoke light-alloy wheels. There's also a 320-l roofbox from the MINI Original Accessories range: it opens on both sides and is mounted on MINI roof rails.

MINI Original Accessories
mini.com/accessories



2 extra doors open up untold opportunities, and you still get all of the classic MINI go-kart feeling thanks to a low centre of gravity, wide track and stiff chassis.

3 DOORS. SEATS 4.



Compact on the outside, with short overhangs, plus loads of space inside – it's as fun to drive today as it was back in 1959. There's room for 4 passengers plus 211 litres of luggage, so wherever you're going, you can take pretty much everything plus the kitchen sink. On winding country roads it handles like a go-kart. It also has a small turning circle, which is handy for nimble manoeuvring in the concrete jungle.

FIVE DOORS. SAME MINI FEELING.



5 seats, noticeably more legroom in the back and 30% more luggage space – the benefits of the MINI 5-door speak for themselves. It's highly customizable, agile and a great everyday car with all the striking MINI design traits.



THERE'S MORE THAN ONE WAY TO DRIVE A MINI.

There's also more than one MINI to drive away. Whether you go for the First/One/D, Cooper/D or Cooper S/SD, each one has a different engine and its own feel behind the wheel. But whichever unit you choose, they all have one thing in common: the power and efficiency of MINI Twin Power Turbo technology.

All MINI models are fitted with a track-style sequential 6-speed manual gearbox as standard. A 6-speed Steptronic automatic transmission is available upon request for all models except One First and One D variants, while a 6-speed Steptronic Sport gearbox with shift paddles on the steering wheel is also an option for Cooper S/SD and MINI John Cooper Works models. To find out more about the John Cooper Works model, visit your nearest MINI dealer or go online at mini.com/jcw

With optional MINI Driving Modes, you can adapt the performance of your MINI to match your mood and the driving conditions. In the MID and GREEN modes, optional Dynamic Damping Control softens the suspension to keep the drive enjoyably smooth. If you want to feel like you're tearing up tarmac in a go-kart, select SPORT mode.



MINI One.

Choose from a 1.2-l 3-cylinder petrol engine that delivers 75hp/55kW (One First) or 102hp/75kW (One) or a 1.5-l 3-cylinder diesel unit with an output of 95hp/70kW. Both feature MINI Twin Power Turbo technology. It comes with a Matt Black safety bar, tailgate handle and exterior mirror caps as well as Brilliant Black radiator grille fins. The go-kart feeling starts here.

MINI Cooper.

A 1.5-l 3-cylinder petrol engine (136hp/100kW) and a 1.5-l 3-cylinder diesel version (116hp/85kW) offer a handy blend of oomph and fuel economy. It sports a safety bar, tailgate handle and radiator grille fins in Brilliant Black, 15" aluminium wheels and a Chrome tailpipe trim. An optional contrast colour for the roof and mirror caps is also available.

MINI Cooper S.

With a 2.0-l 4-cylinder petrol engine (192hp/141kW) or a 2.0-l 4-cylinder diesel unit (170hp/125kW), the Cooper S packs the biggest punch. The air intakes in the bumper and bonnet, rear apron with diffusor, central twin-pipe exhaust system and custom rear spoiler all hint at the power waiting to be unleashed on the road.

WHICH ONE'S YOURS?

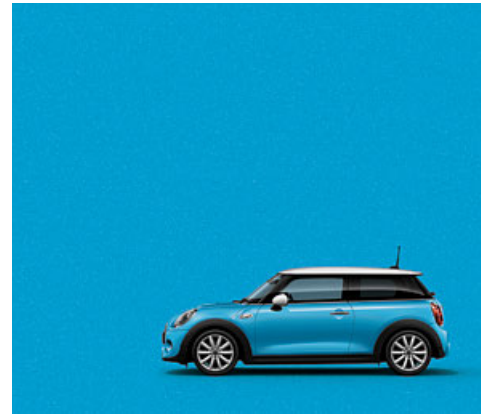

Electric Blue*



Deep Blue

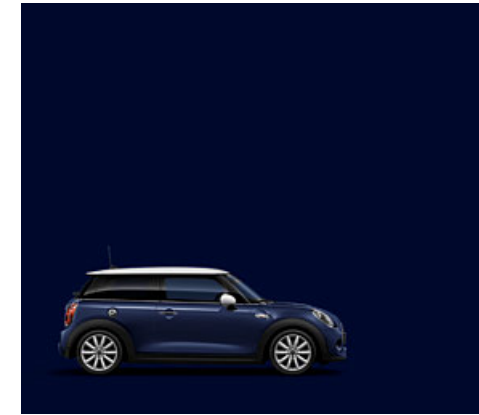

MINI Yours Lapisluxury Blue



British Racing Green*



Pepper White

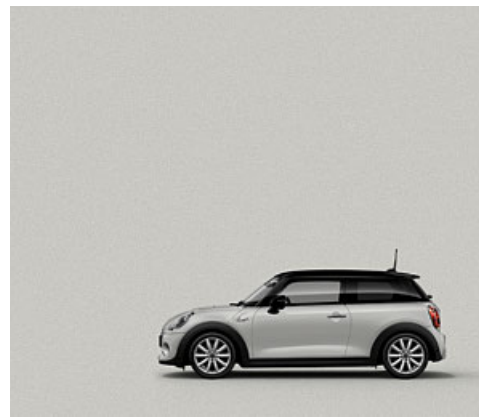

White Silver*



Melting Silver*



Moonwalk Grey*

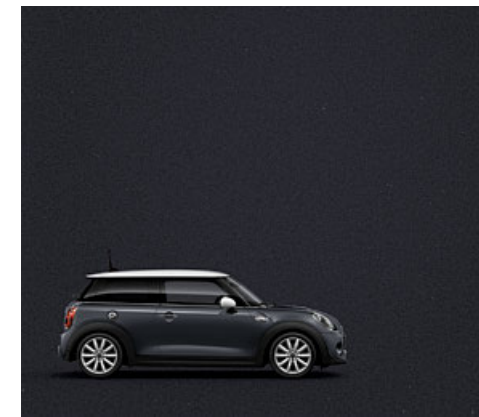

Thunder Grey*/***

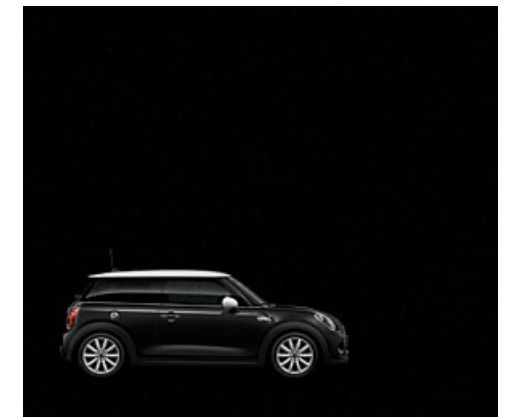

Midnight Black*

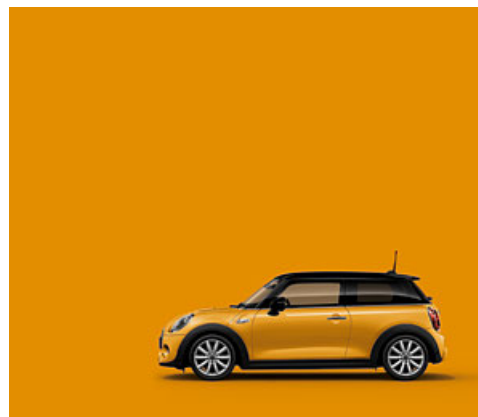

Volcanic Orange

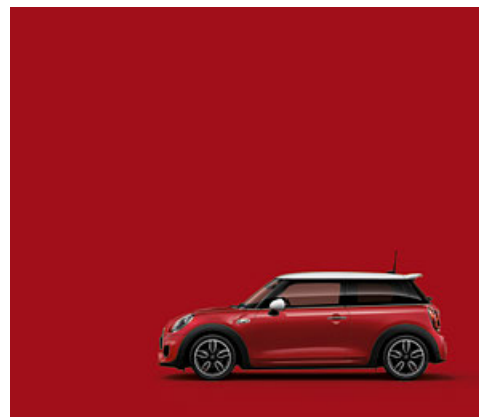

Chili Red**

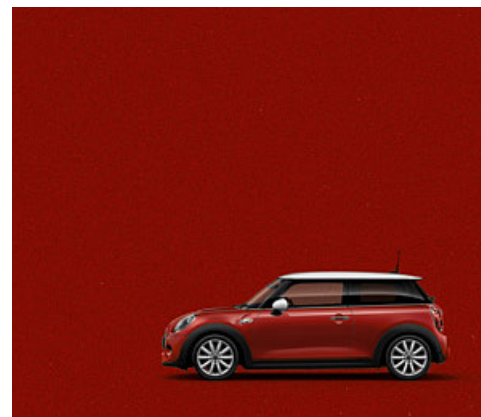

Blazing Red*

* Metallic.
 ** Only available in conjunction with the John Cooper Works Exterior package.
 *** Only available for Cooper S.

Roof and exterior mirror caps.

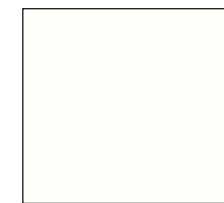

Aspen White

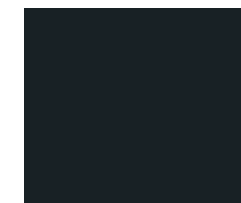

Jet Black

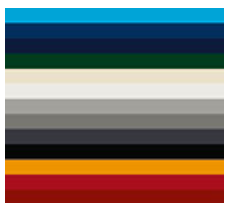

Body colour



PICK YOUR LOOK.

- ❶ 18" MINI Yours Vanity Spoke, 2-tone
- ❷ 18" John Cooper Works Cup Spoke, 2-tone*
- ❸ 18" Cone Spoke, Silver
- ❹ 18" Cone Spoke, White
- ❺ 18" John Cooper Works Pro Double Spoke 534, Matt Black**
- ❻ 18" John Cooper Works Pro Cross Spoke 506, burnished Jet Black**
- ❼ 17" John Cooper Works Track Spoke, Black*
- ❽ 17" Roulette Spoke, 2-tone
- ❾ 17" Cosmos Spoke, Silver
- ❿ 17" Cosmos Spoke, Black
- ⓫ 17" Tentacle Spoke, Silver
- ⓬ 17" Multispoke 505, Liquid Black**
- ⓭ 16" Victory Spoke, Black
- ⓮ 16" Loop Spoke, Silver
- ⓯ 15" Heli Spoke, Silver

* Only available in combination with the John Cooper Works Exterior and John Cooper Works Chili packages.
 ** Available at mini.com/accessories

CHOOSE A STYLE THAT SUITS YOU.

Add a personal touch to the interior of your MINI with a choice of 4 Colour Lines, 8 interior surface styles and more. For a detailed look at the options available, just turn the page.

The image below shows the MINI Yours Dark Cottonwood Interior Style, Satellite Grey Colour Line and Lounge leather upholstery in Satellite Grey.



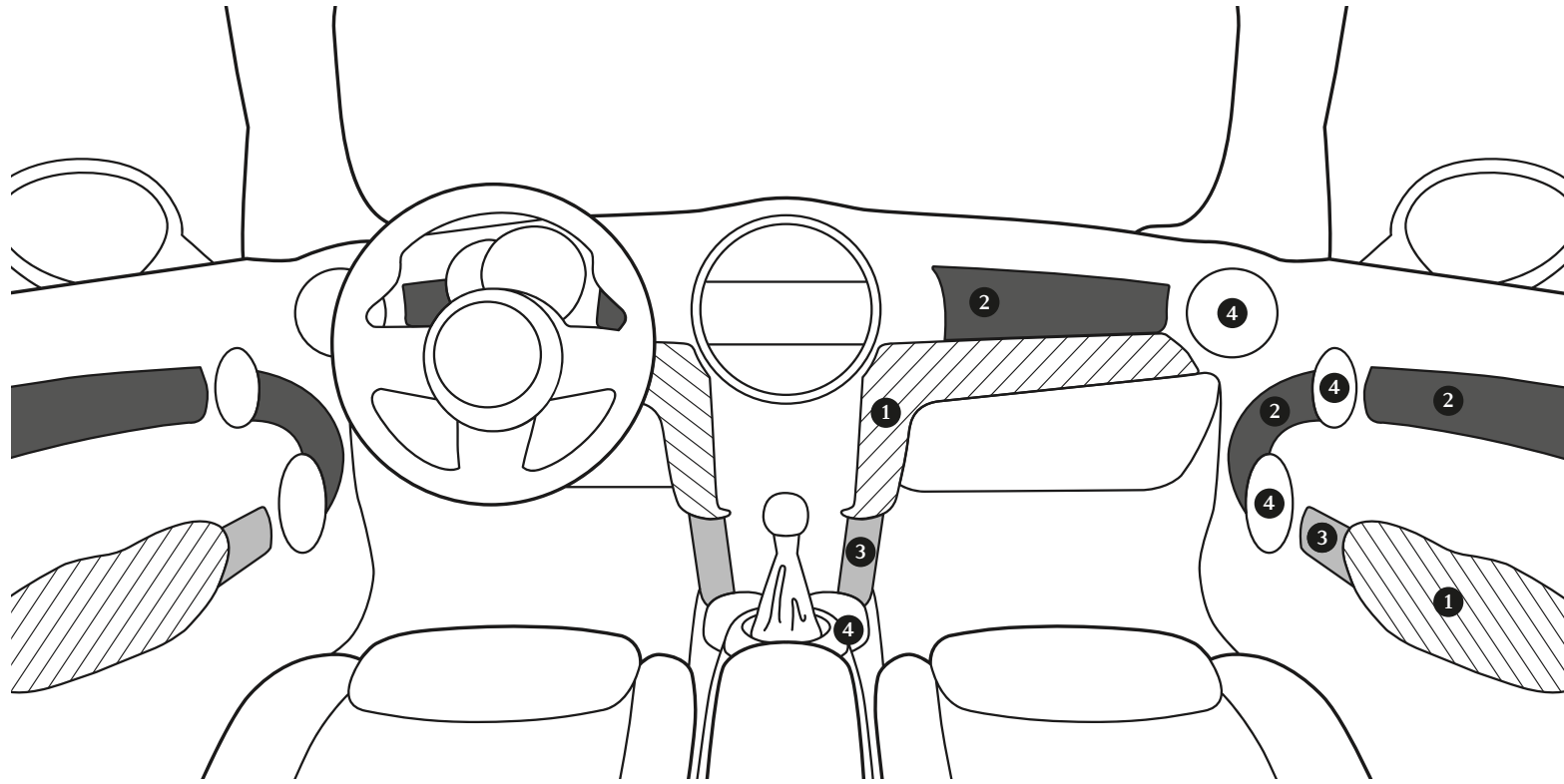

INTERIOR ELEMENTS IN DETAIL.

To help you put together the interior that suits you best, we've divided it up into 4 key design elements. The Colour Line (1) determines the colour of the armrests and knee rolls. The interior surfaces option (2) allows you to choose the material for the decorative door trims and cockpit trims as well as selected structural elements (3). The 3 MINI Yours styles include LED piping, which emits your choice of a range of colours thanks to Ambient Lighting. To round it all off, you can choose the colour for the decorative rings (4) around the loudspeakers, door handles, air vents and gear selector lever.

[mini.com/configurator](https://www.mini.com/configurator)

1 4 Colour Lines.



Carbon Black



Dark Truffle



Glowing Red

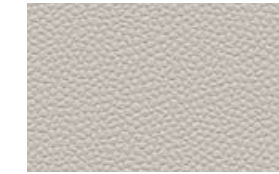

Satellite Grey

2 8 interior surface styles.

The examples below show the materials for the cockpit trim (left) and decorative door trim (right).

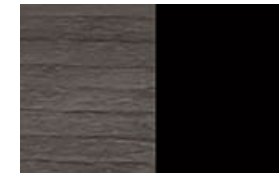

MINI Yours Interior Style
Dark Cottonwood

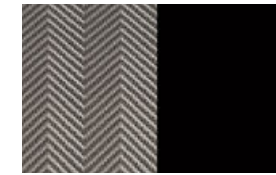

MINI Yours Interior Style
Fibre Alloy



MINI Yours Interior Style
Off-White

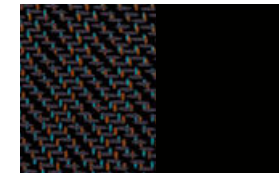

Firework



Piano Black



Dark Silver

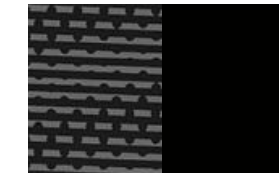

Black Chequered



Hazy Grey
(no decorative door trim)

3 2 structural element styles.

Piano Black structural elements are the ideal complement to the optional interior surface styles. The exception here is the MINI Yours Interior Style Off-White: the structural elements are finished in Brilliant Off-White.

4 3 decorative ring styles.

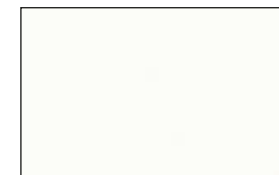

Porcelain Matt White*

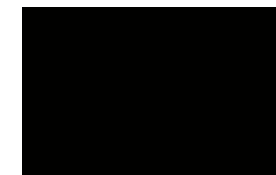

Piano Black



Chrome Line

* Only available in conjunction with MINI Yours Off-White Interior Style.

AT HOME IN SECONDS.



Cross Punch leather sport seat,
Carbon Black



John Cooper Works
Dinamica/leather sport seat,
Carbon Black

COMFORT OF EVERY KIND.



Lounge leather
sport seat,
Satellite Grey



Cross Punch leather
sport seat,
Dark Truffle



Black Pearl cloth/leatherette
sport seat,
Carbon Black



Diamond cloth/leather
sport seat,
Carbon Black



MINI Yours Lounge leather*,
Carbon Black

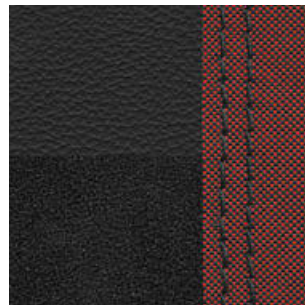

John Cooper Works
Dinamica/leather,
Carbon Black



Lounge leather*,
Satellite Grey



Cross Punch leather*,
Dark Truffle



Cross Punch leather*,
Carbon Black



Diamond cloth/leatherette,
Carbon Black

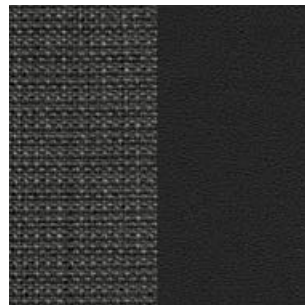

Black Pearl cloth/leatherette,
Carbon Black

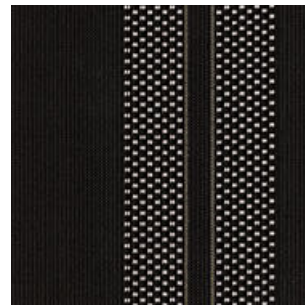

Double Stripe cloth,
Carbon Black



Firework cloth,
Carbon Black

MINI YOURS.

The Carbon Black MINI Yours seat in luxurious Lounge leather isn't just made – it's crafted. The smooth feel of the leather against your hand, the detailed stitching of the Union Jack in the headrest, the braided edging ... the beauty is in the detail.

[mini.com/configurator](https://www.mini.com/configurator)



* Leather upholstery includes seats (base and backrest), and front and rear headrests.

LAST ROW. FIRST CLASS.

IT'S IN YOUR HANDS.



The MINI 3-door.

The back of the MINI 3-door has plenty of space for 2 comfortable individual seats. The ISOFIX child seat mounting system is fitted as standard. The seats on the left are upholstered in MINI Yours Lounge leather in Carbon Black. The headliner is in Anthracite.



The MINI 5-door.

You can comfortably fit 3 people in the back of the MINI 5-door. The image shows MINI Yours Lounge leather seats in Carbon Black, Off-White decorative door trims and armrests in Shadow Grey. With Ambient Lighting – available as part of the MINI Excitement package – you can light up the interior with the colour of your choice.



The choice is yours. Check out the exclusive MINI Yours steering wheel (1), made from soft nappa leather, with Grey stitching and a Union Jack emblem, or the non-slip John Cooper Works sports leather steering wheel (2) with John Cooper Works badge, perforated leather and contrast stitching in Chili Red. Once you get your hands on one, you won't want to let go.

- 1 MINI Yours sports leather steering wheel with multifunction option
- 2 John Cooper Works sports leather steering wheel with multifunction option
- 3 3-spoke sports leather steering wheel with multifunction option
- 4 2-spoke standard steering wheel

BIG ON SMALL DETAILS: MINI YOURS.

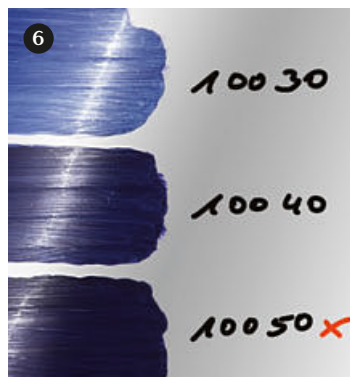
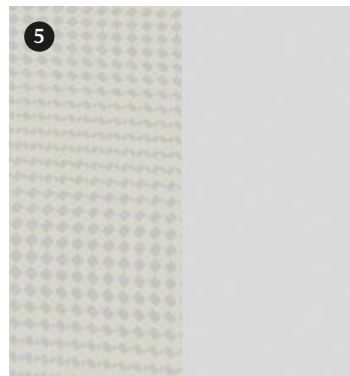

The MINI Yours customization programme provides a wealth of options for those who prize individuality and refined style. The range represents the best of British craftsmanship, and each item has its own story to tell.

Here are a few examples: 2-tone MINI Yours Vanity Spoke 18" light-alloy wheels (1) in the custom MINI Yours colour Spectre Grey, the MINI Yours sports leather steering wheel with soft nappa leather and contrast stitching (2), MINI Yours Fibre Alloy (3), Dark Cottonwood (4) (with genuine material in the cockpit trim) and Off-White (5) Interior Styles and the spectacular exterior colour MINI Yours Lapisluxury Blue – a deep shade of ultramarine (6). Look closely and you'll see the Union Jack and sewing needle in the MINI Yours logo (7) on the the MINI Yours Lounge leather seat in Carbon Black (8), which also comes with braided edging. Another Union Jack is stitched to the back of the headrest.



MINI CONNECTED: HELLO WORLD.

Between MINI Connected and its compatible apps, you've got everything you could need to take the hassle out of your journey – or inject a few more thrills into it. You can check your calendar for today's schedule, bring up search results directly in the navigation system, discover new tunes using one of several popular music apps or listen to an audiobook. Other highlights include controlling your GoPro from the centre console screen. The MINI Connected XL Journey Mate

smartphone app helps you plan your next journey – before you've even left the house. Once you're on the move, it sends you reminders, shows you traffic jams along your route, the weather at your destination and the journey time. It'll even direct you to the nearest parking spot or petrol station. And with the Glympse app, you can share your current location with friends.

WIRED TO PERFECTION.

With the Wired package and Professional navigation system, you can take full advantage of the MINI Connected world of infotainment. The MINI Centre Instrument boasts a screen diagonal of 8.8 inches/22.4 cm, a 3D satellite map view with split screen function and 20 GB of storage for entertainment files. It can also be easily operated using the MINI Controller with touchpad. Other benefits of the Wired package include an enhanced mobile phone preparation, a multifunction steering wheel and voice control. You can stay connected even when you get out of the car, with the virtual trip planner MINI Connected XL Journey Mate and the Glympse app.

mini.com/connected

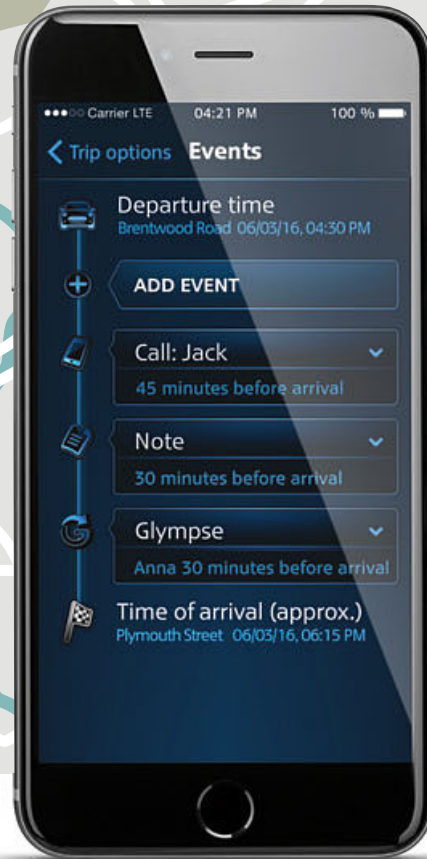

MINI CONNECTED XL JOURNEY MATE.

4:21 p.m.:

Who wants to see the new art exhibition later? Plan it on your phone and set reminders: call your friends and pick them up. Search for petrol stations along the way and load the Glympse app.



WHAT'S THE WEATHER LIKE?

4:27 p.m.:

Check the weather at your destination. It's a bit chilly. Better bring a jacket.



TRANSMIT ROUTE PLAN.

4:29 p.m.:

Hop in and connect your phone.



PETROL STATION INFO.

4:35 p.m.:

Part of the plan: 60 km before the fuel level gets too low, the Journey Mate shows a selection of petrol stations along the route so you can avoid unnecessary detours.



ONLINE TRAFFIC INFO.

4:54 p.m.:

Real-time traffic update: there's a hold-up ahead. The zoom function makes it easier to avoid sudden bottlenecks. Fire up Spotify and kill some time with in-car karaoke.

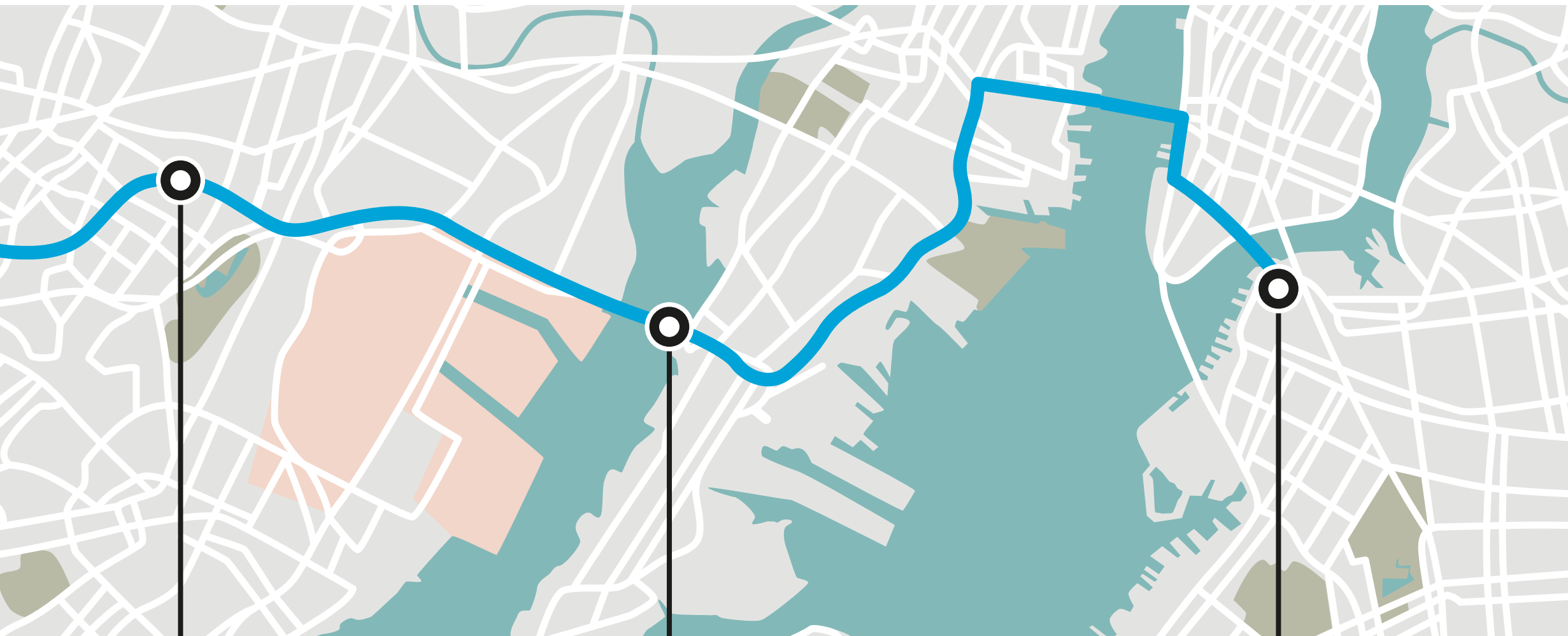

GOT EVERYTHING?

5:30 p.m.:

Who's missing? As instructed, Journey Mate reminds you to ring your friends, which you can do safely using the hands-free Bluetooth connection as you drive.



A QUICK PIT STOP.

5:45 p.m.:

Journey Mate reminds you to pick up your friends. Thanks to the Glympse app, they can see where you are – there's no need to hunt around for them.



WE'RE HERE.

6:15 p.m.:

Perfect timing. You've arrived and found a place to park. The Last Mile Navigation feature in the Journey Mate smartphone app shows you directions for walking to the gallery.



RADIO MINI BOOST.

The Radio MINI Boost with USB audio and AUX-IN interfaces and a 4-line display is fitted as standard.



RADIO MINI VISUAL BOOST.

Complete with 16.25-cm/6.5" screen, ergonomic MINI Controller, MINI Connected interface and Bluetooth hands-free kit.



MINI NAVIGATION SYSTEM.

Leading the way: a first-class navigation system with GPS, TMC and USB updates. Upgrade for the Radio MINI Visual Boost. Easily operated via the MINI Controller.



MINI NAVIGATION SYSTEM PROFESSIONAL.

Included in the Wired package: the 22.4-cm/8.8" screen in the MINI Centre Instrument houses state-of-the-art technology and puts a wealth of navigation information at your fingertips. It's operated via the MINI Controller with touchpad.



LIGHT UP THE ROAD.

The standard halogen headlights and the optional LED versions are shining examples of the state-of-the-art technology housed in the MINI. The High-Beam Assist, which comes as part of the Driving Assistant system, detects oncoming vehicles and, when travelling at speeds over 50 km/h, automatically dims the lights to avoid dazzling other drivers. It also recognizes when there is sufficient light, e.g. in built-up urban areas, and dims the lights accordingly.

The LED cornering light follows and illuminates the curve of the road, while the LED fog lights and LED additional headlights from the MINI Original Accessories range ensure optimum visibility when the weather takes a turn for the worse. For sunny days, there are omega-shaped daytime running lights in the LED headlights – a hallmark of MINI design.

MINI Original Accessories
mini.com/accessories

THE BEST JOURNEYS BEGIN WITH PEACE OF MIND.

1 Never lose sight of the important things: the MINI Head-Up Display projects key driving information into the driver's line of sight without obstructing his view of the road. Depending on the optional equipment fitted, this data can include speed limits, navigation instructions and cruise control settings.

2 The Driving Assistant is a camera-based solution that increases safety on the road for you and others around you. It recognizes and reports speed limits and no-overtaking zones. When travelling at speeds between 10 and 60 km/h, the Pedestrian Collision and Forward Collision Warning systems, both with city brake function, warn

drivers and automatically brake if a potential collision is detected. At higher speeds, the Forward Collision Warning also registers potential collisions with vehicles in front and preconditions the brakes for rapid responses and shorter stopping distances. If an accident is unavoidable, the city brake function helps reduce impact speed.

3 The Park Assist helps you find a suitable parking space and makes parallel parking easy. All you have to do is brake and accelerate as required.

4 A high-resolution reversing camera displays a clear view of the area behind the car in the MINI Centre Instrument.

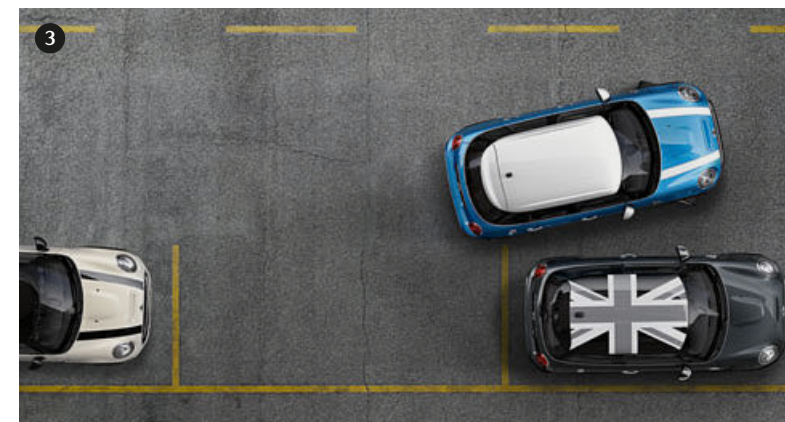



THE EXCLUSIVE JOHN COOPER WORKS PACKAGES.

Inspired by



The John Cooper Works equipment packages: 3 ways to step things up a notch. The Exterior package includes 17" Track Spoke light-alloy wheels in Black, rear spoiler in the same colour as the roof, and striking track-style front and rear aprons with painted side skirts.

If you want the motorsport feel inside as well as out, go for the John Cooper Works Interior package. You get Red contrast

stitching on the John Cooper Works sports leather steering wheel and John Cooper Works leather gear lever knob, an Anthracite headliner, stainless steel pedal pads plus optional John Cooper Works Dinamica/leather sport seats.

The John Cooper Works Chili package is the ultimate upgrade. It combines everything in the Exterior and Interior packages with the Chili bundle. See page 39 for details.



JOHN COOPER WORKS TUNING: TOP PERFORMANCE.

For even more racetrack flair, retrofit your MINI with John Cooper Works Pro Tuning accessories like John Cooper Works Pro 18" Cross Spoke 506 light-alloy wheels in burnished Jet Black, John Cooper Works Pro aerodynamic components or Red 17" sport brakes. For a suitably nerve-tingling sound,

add the optional John Cooper Works Pro Tuning kit, which enhances engine output and features the John Cooper Works Pro valve silencer and a tailpipe trim in Carbon or Chrome.

John Cooper Works Pro Tuning
mini.com/accessories

Inspired by



A LITTLE EXTRA TO SAVOUR.

If the practically endless list of individual equipment options puts your head in a spin, keep things simple. Spruce up your MINI with one (or more) of our equipment packages. Choose from Salt, Pepper and Chili, each expanding on the one below it. There's also the Wired package, which is crammed with cutting-edge connectivity options. A lot of thought went into each package: the options included were chosen to complement each other and suit your needs. It's also much cheaper to buy the bundle instead of each option individually. The same goes for the John Cooper Works packages outlined earlier in the brochure.

WIRED



Communication is everything. That's why we're offering the Wired package with Professional navigation system, operated via the MINI Controller and touchpad. It includes the MINI Centre Instrument with 22.4-cm/8.8" screen, sports leather steering wheel with multifunction option, voice control, 3D satellite map view, MINI Connected and MINI Connected XL Journey Mate, 20 GB of entertainment storage and mobile phone preparation for the snap-in adapter in the centre armrest.

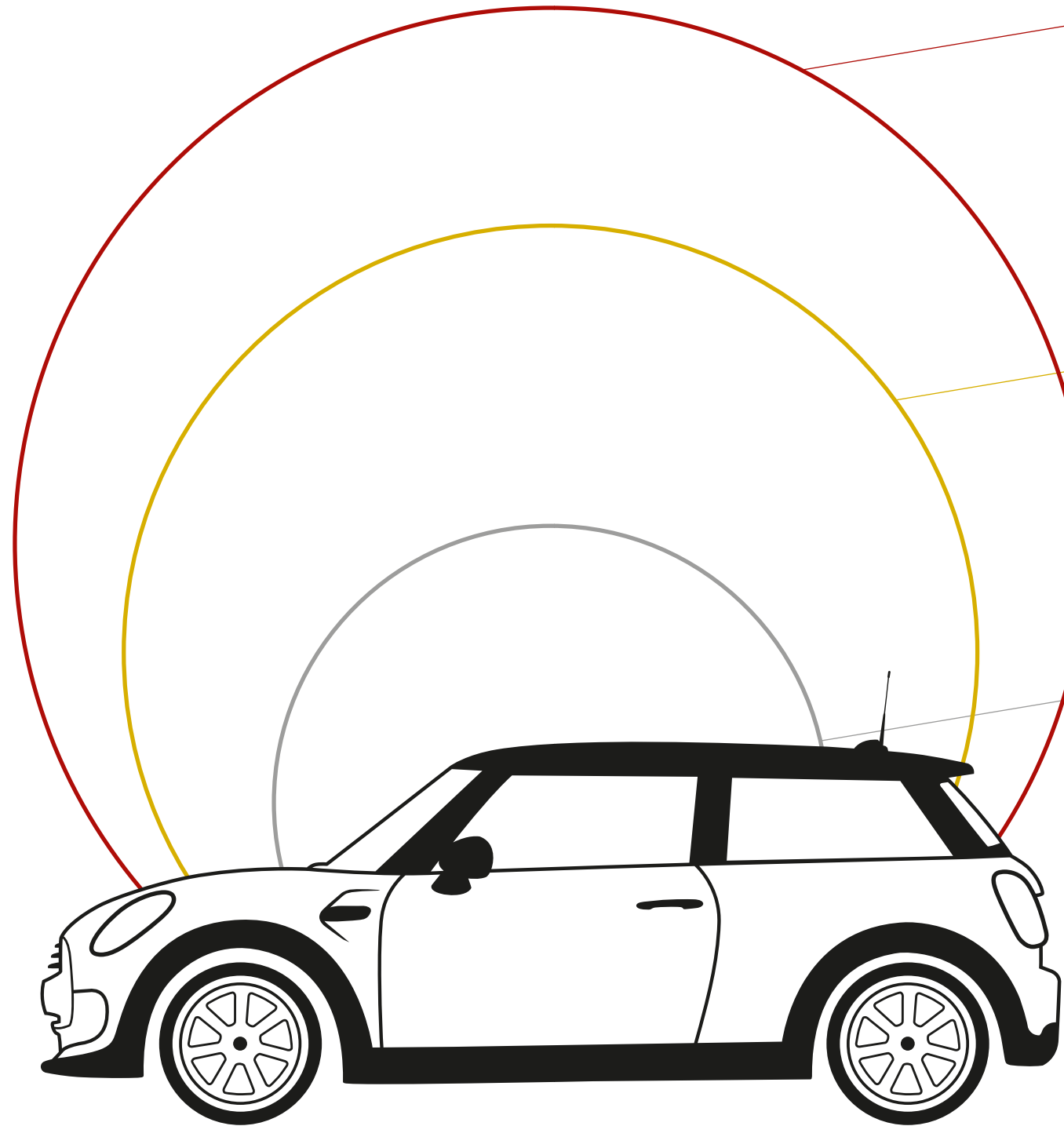

CHILI.

This one has pretty much everything – and motorsport fans will lap it up. Take all the extras in the Salt and Pepper packages and add MINI Driving Modes, cloth/leather sport seats, a sports leather steering wheel with multifunction option, cruise control with brake function, LED headlights and fog lights, and a selection of light-alloy wheels: 16" Victory Spoke in Silver for MINI One models, 17" Tentacle Spoke in Silver for MINI Cooper models, and 17" Cosmos Spoke in Silver for Cooper S variants.

PEPPER.

The Pepper package has everything in the Salt bundle and more. Extras include a rain sensor with automatic headlight activation, automatic air conditioning, sports leather steering wheel and the MINI Excitement package, which consists of Ambient Lighting – with the full spectrum of colours – and lighting for the exterior door handles. For the MINI One, it has Silver 15" Heli Spoke light-alloy wheels. For the MINI Cooper, 16" Loop Spoke, also in Silver.

SALT.

The Salt equipment package adds a dash of extra comfort and connectivity to the mix. It includes velour floor mats, an on-board computer, the lights and storage packages, air conditioning, fog lights and seat-height adjustment for the front passenger.

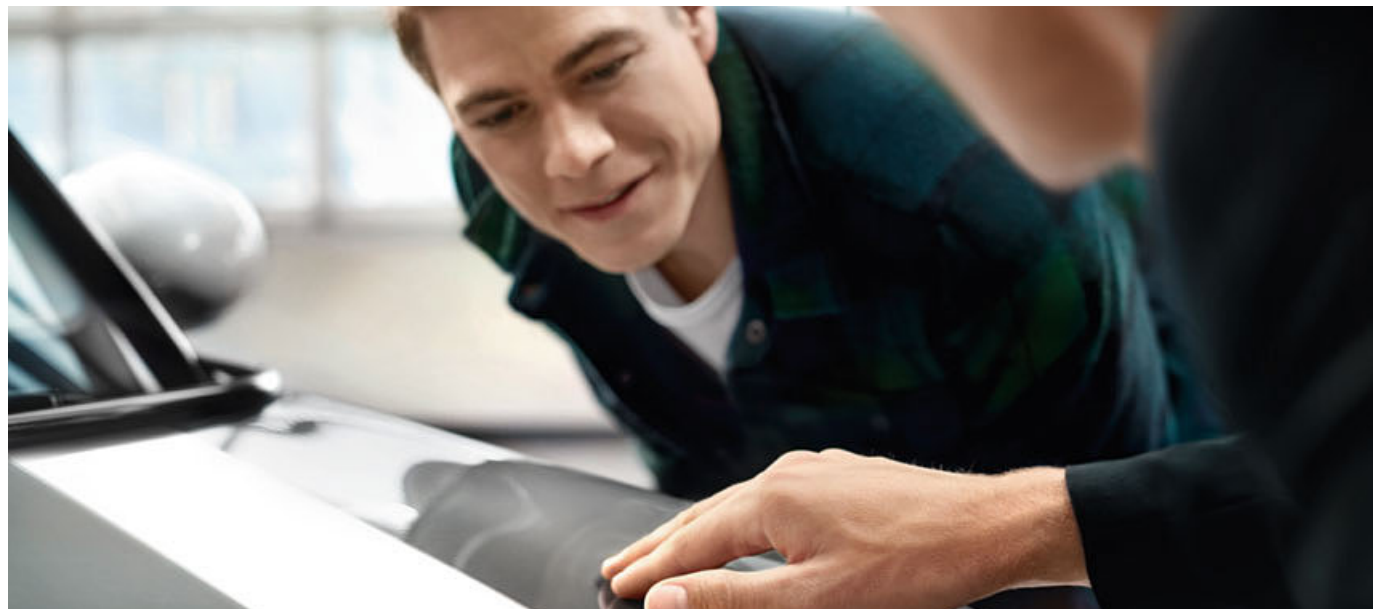

MINI SERVICE.

We've got everything covered.

Our service experts are as passionate about your MINI as you are. They're specially trained to keep it in top shape, so for electrical or mechanical defects, cosmetic or bodywork repairs, or even simply fitting MINI Original Parts, your MINI will be in the best possible hands.

MINI knows best.

Since you can't always think of everything when on the road, your MINI uses its head too. The Condition Based Service feature automatically reminds you when its next service is due, via the MINI Centre Instrument. The MINI TeleServices feature automatically transfers the most important vehicle data to MINI via a built-in SIM card. Your local MINI Service Centre will then contact you to make an appointment if any maintenance is necessary. What's more, in the unlikely event of a breakdown, you can also contact the specialists on our MINI Breakdown Service team directly. If you don't need to use the service, you can deactivate it at any time. The Intelligent Emergency Call option is required to use MINI TeleServices.

At a glance: MINI Service Inclusive.

2 packages give you full control over what you pay for maintenance and repair work. You decide the duration and amount of cover, and you can even transfer it to a new owner. With MINI Service Inclusive, you can book your MINI in with any MINI Service Partner around the world. For more information on these packages and additional extended warranty options, visit mini.com/serviceinclusive

We'll keep your MINI mobile.

MINI Mobile Service and the MINI Accident Hotline are there when you need them, 24 hours a day, 365 days a year. If you have a breakdown, you'll get specialist help every step of the way: we'll send expert technicians to help you on site, dispatch a BMW Group replacement vehicle to get you back on the road, provide car recovery and towing services and more. In the event of an accident, we'll be there for you with a comprehensive range of services. Find out more online at mini.com



MINI FINANCIAL SERVICES.

The key to the car of your dreams.

MINI Financial Services represents the quickest way to the car of your dreams. With MINI Leasing, you pay to use the vehicle and not a penny more. MORE MINI packages provide a host of attractive extras, such as suitable insurance, a tailored service deal or even a combination of both.

If you want to own a MINI but stay flexible with your financing, you'll find a favourable deal with MINI Finance. And for total peace of mind, check out MINI Insurance*.

Find out more about MINI Financial Services online at mini.com or visit your local MINI dealership**.

* Contractual partner and risk carrier is Allianz Versicherungs-AG.

** Vehicle also includes a service package. See service package agreement for details.

MINI Financial Services is a trade name of BMW Bank GmbH, Heidemannstr. 164, 80939 Munich, Germany.

Warranty.

Every MINI is supplied with a 2-year dealer warranty against manufacturing defects. The MINI dealership where the purchase was made is responsible for honouring the warranty. Repair work can be carried out at any authorized MINI dealer, MINI Service Authorized Workshop or any other service centre authorized by MINI. Defects arising in the first 6 months after purchase are deemed by law to have existed at the time of purchase and the dealer has the onus of proving that the vehicle is not defective due to a manufacturing defect. Every MINI also comes with a 12-year anticorrosion warranty, which covers the vehicle against rusting of the body panels. The painted surfaces of the car are covered by a 3-year warranty. This warranty does not cover damage to the vehicle body or under-body caused by stone impacts, scratches or dents, accident damage or other damage caused by environmental factors. Failure to comply with the service schedule provided by the manufacturer may invalidate this warranty.

Recycling.

At every stage, from design to disassembly, recycling is central to the MINI philosophy. For example, all the materials used in each vehicle's manufacture are selected because they can be used in the most sustainable and environmentally friendly way possible. That way, every MINI can be efficiently and ecologically recycled when its driving days are finally done. We've been working on this approach since 1994 at the BMW Group Recycling and Disassembly Centre in Munich, the only facility of its kind. Your MINI dealer will be pleased to advise you on the disposal of your old vehicle, or you can visit mini.com

TECHNICAL DATA FOR THE MINI 3-DOOR.

Engine ^{1,2}		One First	One	One D	Cooper	Cooper D	Cooper S	Cooper SD
Cylinders/layout/valves per cylinder		3/in-line/4	3/in-line/4	3/in-line/4	3/in-line/4	3/in-line/4	4/in-line/4	4/in-line/4
Capacity	cm ³	1198	1198	1496	1499	1496	1998	1995
Stroke/bore	kW/hp/ rpm	55/75/ 3600	75/102/ 4000	70/95/ 4000	100/136/ 4400-6000	85/116/ 4000	141/192/ 5000-6000	125/170/ 4000
Max. torque/revs	Nm/rpm	150/1250-3500	180/1400-3600	220/1500-2500	220/1250-4400	270/1750-2250	280/1250-4600	360/1500-2750
Compression ratio/recommended fuel	:1	10.2/91-98 RON	10.2/91-98 RON	16.5/diesel	11/91-98 RON	16.5/diesel	11/91-98 RON	16.5/diesel
Performance¹								
Max. speed	km/h	175	195 [195]	190	210 [210]	205 [204]	235 [233]	227 [225]
Acceleration 0-100 km/h	sec.	12.8	9.9 [10.2]	11.0	7.9 [7.8]	9.2 [9.2]	6.8 [6.7]	7.3 [7.2]
Acceleration 80-120 km/h (5th gear)	sec.	15.5	11.8	11.6	9.3	8.9	6.4	6.5
Fuel consumption^{1,2}								
Urban	l/100 km	6.5-6.5	5.9-5.8 [5.9-5.8]	4.0-3.9	5.8-5.7 [6.0-5.9]	4.4-4.3 [4.3-4.2]	7.7-7.6 [6.9-6.8]	5.0-4.9 [4.7-4.6]
Extra-urban	l/100 km	4.3-4.2	4.1-4.0 [4.3-4.2]	3.2-3.1	3.9-3.8 [4.1-4.0]	3.2-3.1 [3.5-3.5]	4.8-4.6 [4.5-4.4]	3.7-3.6 [3.7-3.6]
Combined	l/100 km	5.2-5.1	4.8-4.7 [4.9-4.8]	3.5-3.4	4.6-4.5 [4.8-4.7]	3.6-3.5 [3.8-3.7]	5.8-5.7 [5.4-5.3]	4.1-4.0 [4.1-4.0]
CO ₂ emissions (combined cycle)	g/km	120-118	111-109 [114-112]	92-89	107-105 [112-109]	95-92 [99-98]	136-133 [126-123]	109-106 [107-104]
Tank capacity, approx.	l	40	40	44	40	44	44	44
Range	km	785	850 [835]	1295	890 [850]	1255 [1190]	770 [830]	1100 [1100]
Weight/Luggage Capacity¹								
Unladen weight EU ³	kg	1160	1165 [1195]	1190	1160 [1190]	1210 [1225]	1235 [1250]	1250 [1265]
Max. permitted weight	kg	1565	1570 [1600]	1595	1565 [1595]	1615 [1630]	1640 [1655]	1655 [1670]
Max. permitted load	kg	480	480	480	480	480	480	480
Max. permitted axle load, front/rear	kg	860/760	865/765 [895/765]	890/765	870/755 [900/755]	910/755 [925/755]	915/765 [930/765]	930/765 [945/765]
Luggage capacity	l	211-731	211-731	211-731	211-731	211-731	211-731	211-731
Wheels								
Tyre dimensions		175/65 R15 84H	175/65 R15 84H	175/65 R15 84H	175/65 R15 84H	175/65 R15 84H	195/55 R16 87W	195/55 R16 87W
Wheel dimensions		5.5 J x 15	5.5 J x 15	5.5 J x 15	5.5 J x 15	5.5 J x 15	6.5 J x 16	6.5 J x 16
Material		Steel	Steel	Steel	Lightweight alloy	Lightweight alloy	Lightweight alloy	Lightweight alloy

¹ All figures relate to vehicles with the standard 6-speed manual transmission. Figures in brackets relate to vehicles with 6-speed Steptronic transmission.

² All MINI models comply with the EU6 exhaust emissions standard. Fuel consumption is determined in accordance with the ECE driving cycle (as defined in directive 80/1268/EEC), made up of approximately one third urban and two thirds extra-urban driving (based on the distance covered). CO₂ emissions are measured separately from fuel consumption. Figures relate to standard-specification vehicles and may vary significantly where optional equipment (including wider tyres) is fitted. Figures for fuel consumption and CO₂ emissions may vary depending on the wheels and tyres fitted.

³ Assuming car is fuelled to 90% of usable tank capacity, and allowing 68 kilograms for the driver and 7 kilograms for luggage. Figure quoted is for standard-specification vehicles. Optional equipment will increase this figure.

MINI 3-DOOR DIMENSIONS.

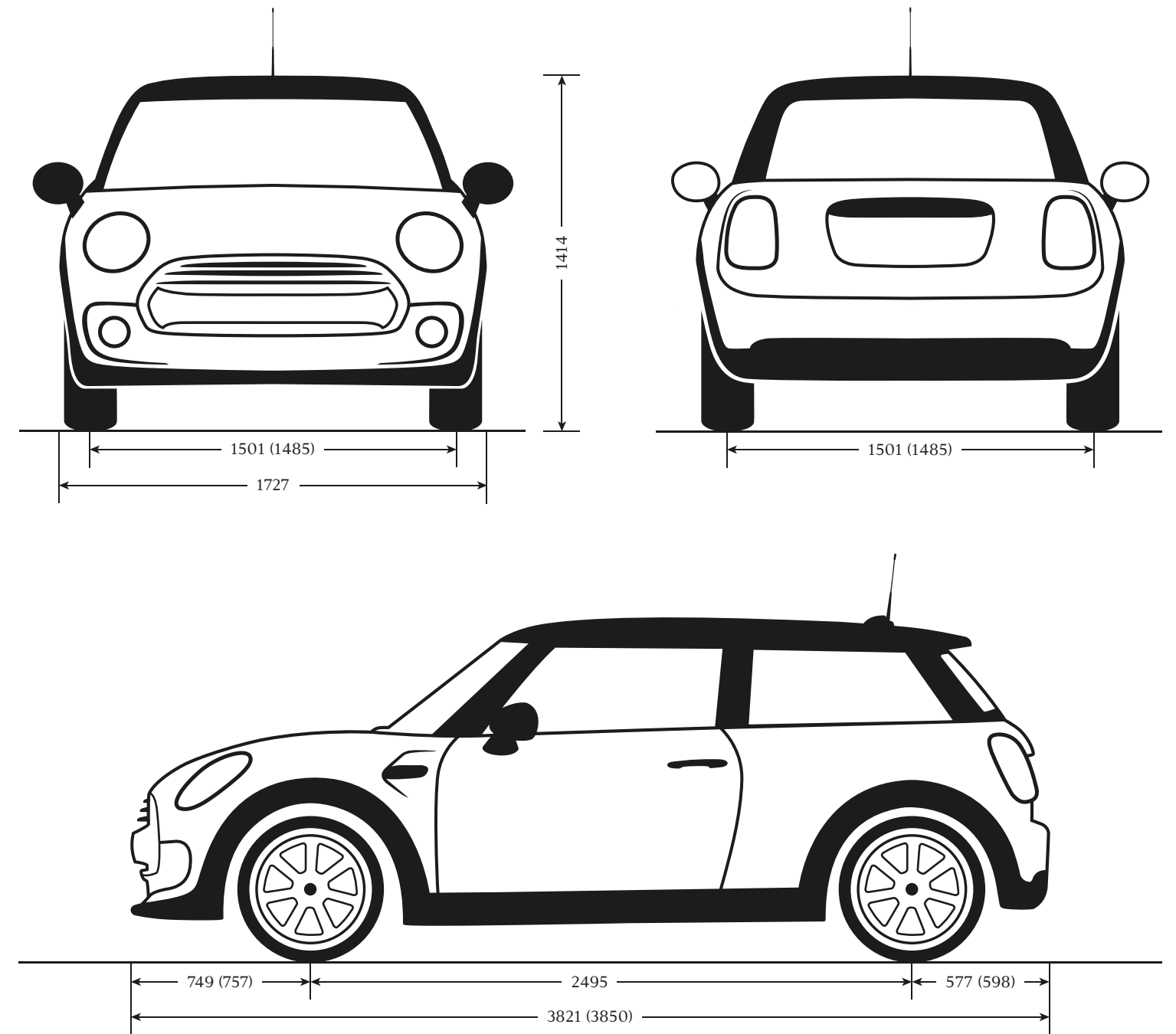

Cooper S track width: 1485 front and rear.
All figures in mm.
Cooper S figures in brackets.

TECHNICAL DATA FOR THE MINI 5-DOOR.

Engine ^{1,2}		One First	One	One D	Cooper	Cooper D	Cooper S	Cooper SD
Cylinders/layout/valves per cylinder		3/in-line/4	3/in-line/4	3/in-line/4	3/in-line/4	3/in-line/4	4/in-line/4	4/in-line/4
Capacity	cm ³	1198	1198	1496	1499	1496	1998	1995
Stroke/bore	kW/hp/ rpm	55/75/ 3600	75/102/ 4000	70/95/ 4000	100/136/ 4400-6000	85/116/ 4000	141/192/ 5000-6000	125/170/ 4000
Max. torque/revs	Nm/rpm	150/1250-3500	180/1400-3600	220/1500-2500	220/1250-4400	270/1750-2250	280/1250-4600	360/1500-2750
Compression ratio/recommended fuel	:1	10.2/91-98 RON	10.2/91-98 RON	16.5/diesel	11/91-98 RON	16.5/diesel	11/91-98 RON	16.5/diesel
Performance¹								
Max. speed	km/h	172	192 [192]	187	207 [207]	203 [202]	232 [230]	225 [223]
Acceleration 0-100 km/h	sec.	13.4	10.1 [10.5]	11.4	8.2 [8.1]	9.4 [9.5]	6.9 [6.8]	7.4 [7.3]
Acceleration 80-120 km/h (5th gear)	sec.	16.5	12.8	12.1	9.6	9.2	6.7	6.7
Fuel consumption^{1,2}								
Urban	l/100 km	6.7-6.6	6.0-5.9 [6.0-5.9]	4.1-4.0	5.9-5.9 [6.1-6.0]	4.5-4.4 [4.4-4.3]	7.9-7.7 [7.0-6.9]	5.1-5.0 [4.8-4.7]
Extra-urban	l/100 km	4.4-4.3	4.2-4.2 [4.4-4.3]	3.3-3.2	4.1-4.0 [4.2-4.1]	3.3-3.2 [3.6-3.5]	4.9-4.8 [4.6-4.5]	3.8-3.6 [3.8-3.7]
Combined	l/100 km	5.3-5.2	4.9-4.8 [5.0-4.9]	3.6-3.5	4.8-4.7 [4.9-4.8]	3.7-3.6 [3.9-3.8]	6.0-5.9 [5.5-5.4]	4.3-4.1 [4.2-4.1]
CO ₂ emissions (combined cycle)	g/km	123-121	114-112 [116-114]	94-92	111-109 [114-111]	97-95 [102-99]	139-136 [128-125]	112-109 [109-107]
Tank capacity, approx.	l	40	40	44	40	44	44	44
Range	km	770	835 [815]	1255	850 [835]	1220 [1160]	745 [815]	1075 [1075]
Weight/Luggage Capacity¹								
Unladen weight EU ³	kg	1225	1225 [1250]	1250	1220 [1250]	1265 [1280]	1295 [1315]	1305 [1325]
Max. permitted weight	kg	1680	1680 [1705]	1715	1670 [1700]	1720 [1735]	1750 [1770]	1755 [1775]
Max. permitted load	kg	530	530	540	525	530	530	525
Max. permitted axle load, front/rear	kg	900/845	900/845 [925/845]	910/850	910/835 [940/835]	925/845 [940/845]	950/850 [970/850]	950/850 [970/850]
Luggage capacity	l	278-941	278-941	278-941	278-941	278-941	278-941	278-941
Wheels								
Tyre dimensions		175/65 R15 84H	175/65 R15 84H	175/65 R15 84H	175/65 R15 84H	175/65 R15 84H	195/55 R16 87W	195/55 R16 87W
Wheel dimensions		5.5 J x 15	5.5 J x 15	5.5 J x 15	5.5 J x 15	5.5 J x 15	6.5 J x 16	6.5 J x 16
Material		Steel	Steel	Steel	Lightweight alloy	Lightweight alloy	Lightweight alloy	Lightweight alloy

¹ All figures relate to vehicles with the standard 6-speed manual transmission. Figures in brackets relate to vehicles with 6-speed Steptronic transmission.

² All MINI models comply with the EU6 exhaust emissions standard. Fuel consumption is determined in accordance with the ECE driving cycle (as defined in directive 80/1268/EEC), made up of approximately one third urban and two thirds extra-urban driving (based on the distance covered). CO₂ emissions are measured separately from fuel consumption. Figures relate to standard-specification vehicles, and may vary significantly where optional equipment (including wider tyres) is fitted. Figures for fuel consumption and CO₂ emissions may vary depending on the wheels and tyres fitted.

³ Assuming car is fuelled to 90% of usable tank capacity, and allowing 68 kilograms for the driver and 7 kilograms for luggage. Figure quoted is for standard-specification vehicles. Optional equipment will increase this figure.

MINI 5-DOOR DIMENSIONS.

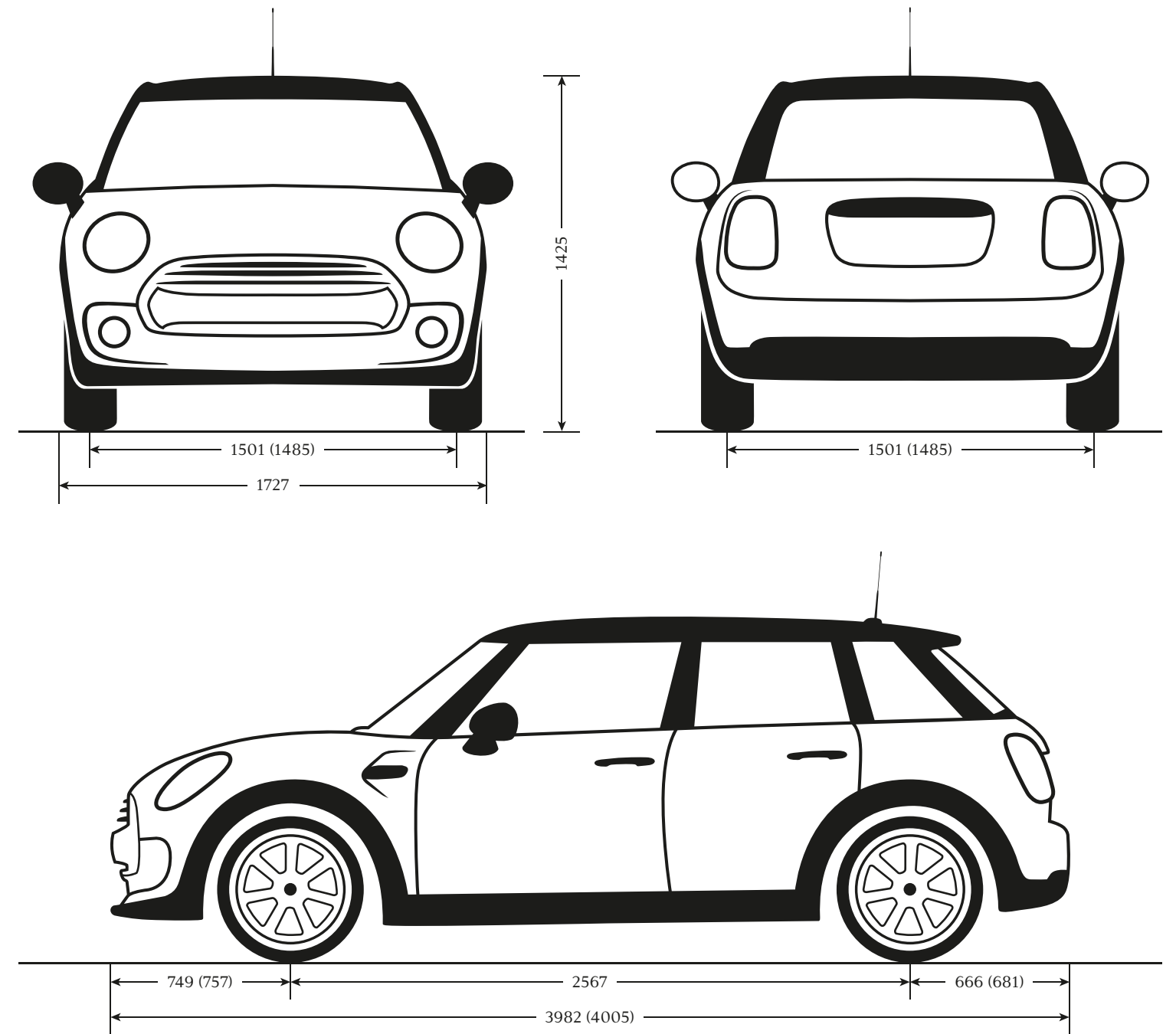

Cooper S track width: 1485 front and rear.
All figures in mm.
Cooper S figures in brackets.



WE'VE SAVED THE BEST FOR LAST: THE TEST DRIVE.

What's the point of revving yourself up without taking it for a spin? Get behind the wheel. Make yourself comfortable in the driver's seat. Listen to the satisfying sound the door makes as it closes behind you. Fasten your seat belt. Adjust the rear-view mirror and start the engine. A whole new experience awaits you: a drive like no other, guaranteed to inspire. So what are you waiting for? Arrange a test drive with your MINI dealer and find out what it feels like to drive a MINI.

mini.com



The models, standard and optional equipment and combinability of options in this catalogue relate to cars supplied by BMW AG for the German market. The availability of standard and optional equipment, and the combinability of options, may vary from country to country within the European Union for all models. For detailed information about the situation in your country, please contact your authorized MINI dealer. Subject to changes in design and equipment.

© BMW AG, Munich, Germany.

Not to be reproduced, wholly or in part, without the written permission of BMW AG, Munich.

For more information, visit
mini.com
or contact MINI customer service.
Phone: 0800 000 6464



facebook.com/mini

MINI ORIGINAL ACCESSORIES
mini.com/accessories

MINI COLLECTION
shop.mini.com

July 2016

